

AOSTM

ADVANCED ORTHOPAEDIC SOLUTIONS

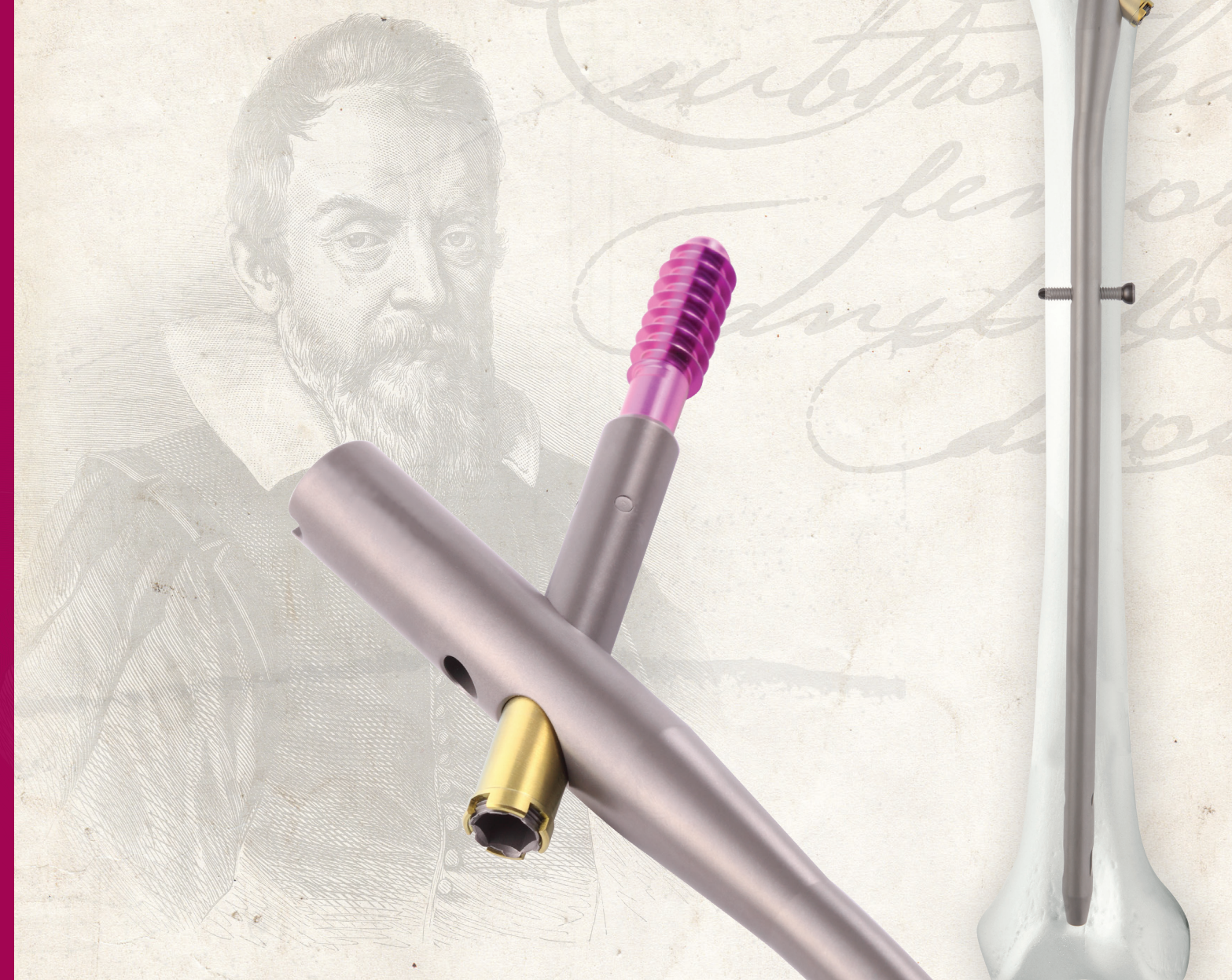

*Galileo*TM

TROCHANTERIC NAIL SYSTEM

Advanced Orthopaedic Solutions
3203 Kashiwa Street
Torrance, CA 90505

T: 310.533.9966
F: 310.533.9876
www.aosortho.com

Follow us @



Made in the USA

P/N: 9066

©2016 Advanced Orthopaedic Solutions. All rights reserved.

Galileo™ Lag Screw

Discover Healing Without Protrusion

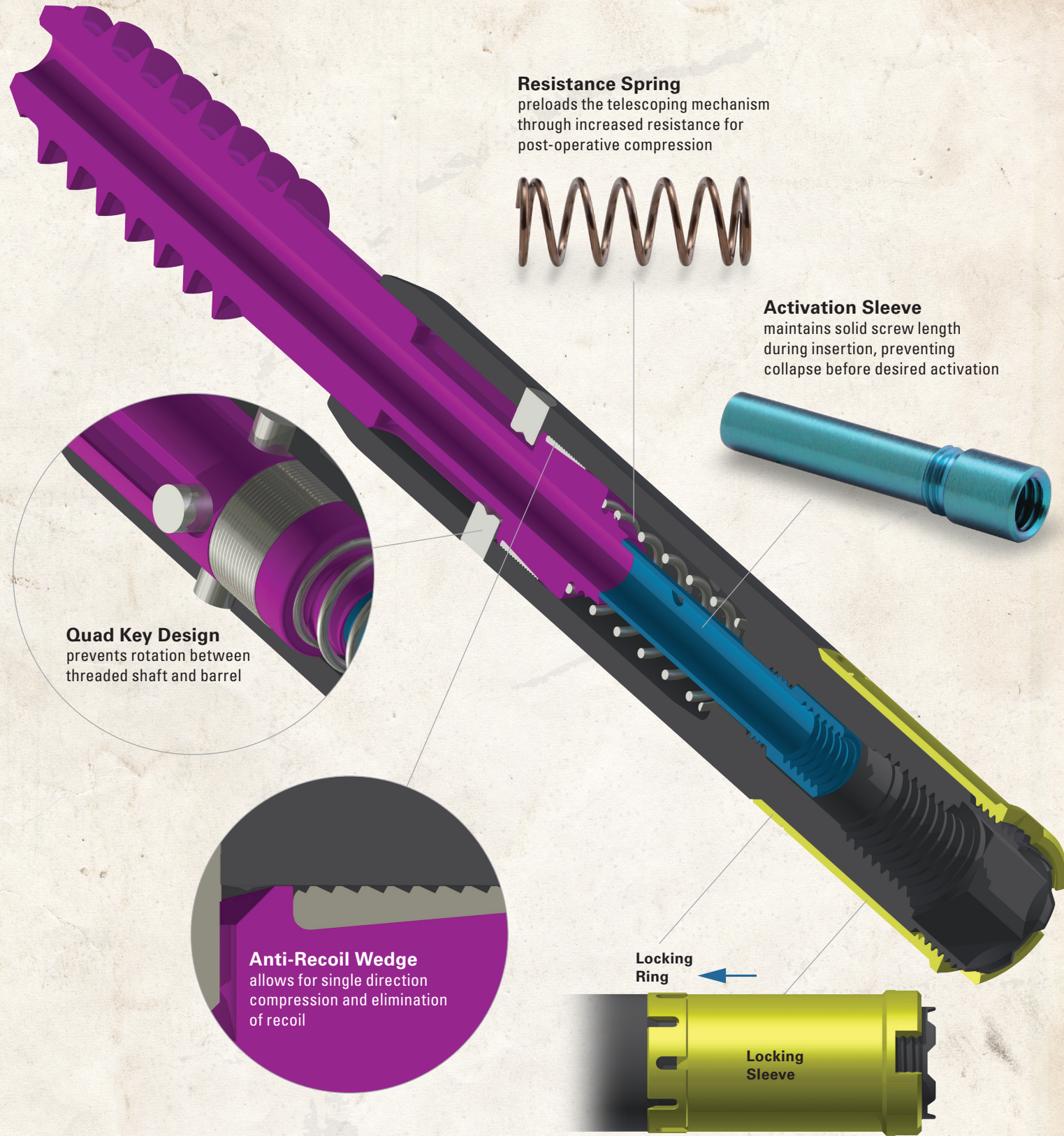

Resistance Spring
preloads the telescoping mechanism through increased resistance for post-operative compression



Activation Sleeve
maintains solid screw length during insertion, preventing collapse before desired activation



Quad Key Design
prevents rotation between threaded shaft and barrel

Anti-Recoil Wedge
allows for single direction compression and elimination of recoil

Locking Ring

Locking Sleeve

Locking Mechanism
secures screw to nail by advancing the locking sleeve and expanding the ring within the nail

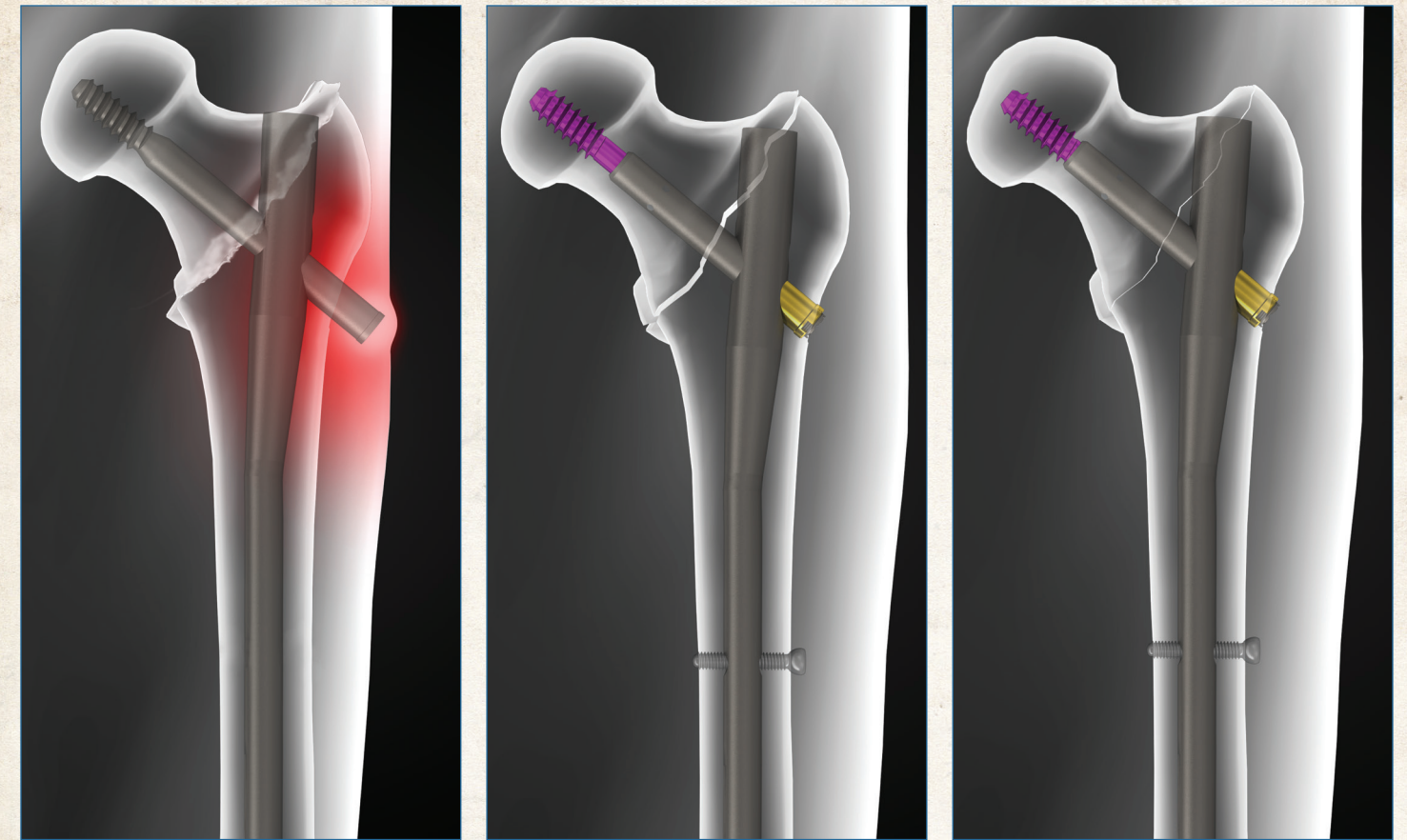

Lateral lag screw protrusion due to fracture settlement increases potential irritation.

Immediate post-operative image prior to fracture settlement. Galileo™ Lag Screw allows for 0-10mm post-operative compression.

Post-operative healing with 10mm compression of the Galileo™ Lag Screw eliminates potential lateral protrusion.

Galileo™ Lag Screw Instrumentation



Compression Sleeve
Used to produce up to 10mm of intraoperative compression

Locking Handle
Controls locking mechanism of the Lag Screw and securely locks and unlocks screw to nail

Insertion Handle
provides nonslip grip to the surgeon and ease of insertion

ES™ Trochanteric Nail

One Piece Construction
Eliminates instability caused by a two piece construction, securing greater targeting accuracy

The Ease of a Short Nail with the Security of a Long Nail

- **Guided Distal Targeting**
- **Reduces Intraoperative Radiographic Exposure**
- **Reduces Peri-Prosthetic Fracture Rate**
- **Increased Torsional Rigidity**

Always On Technology
Securely positions sheath to bone during Lag, A/R, and Cortical Screw insertion

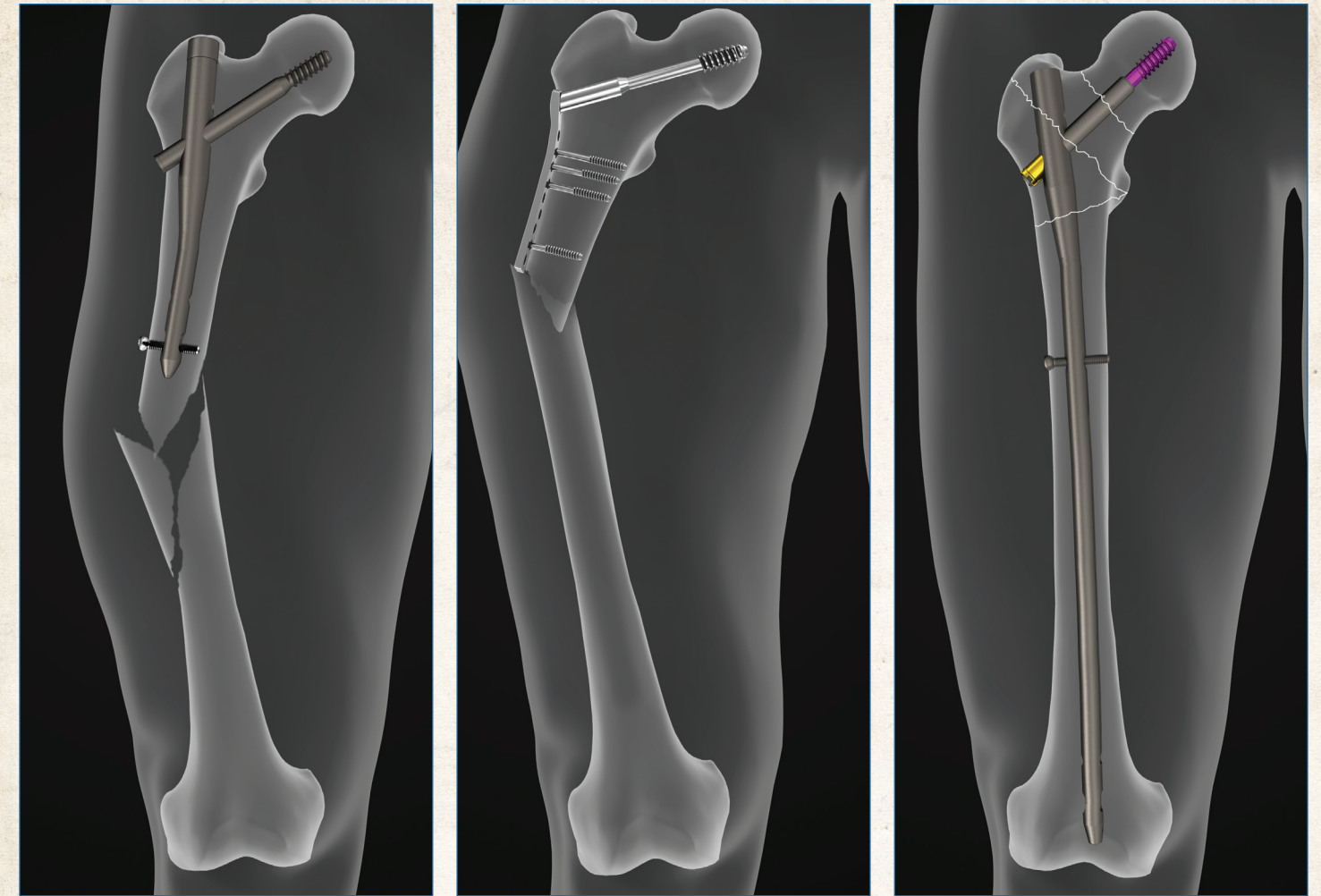

Torsional Rigidity

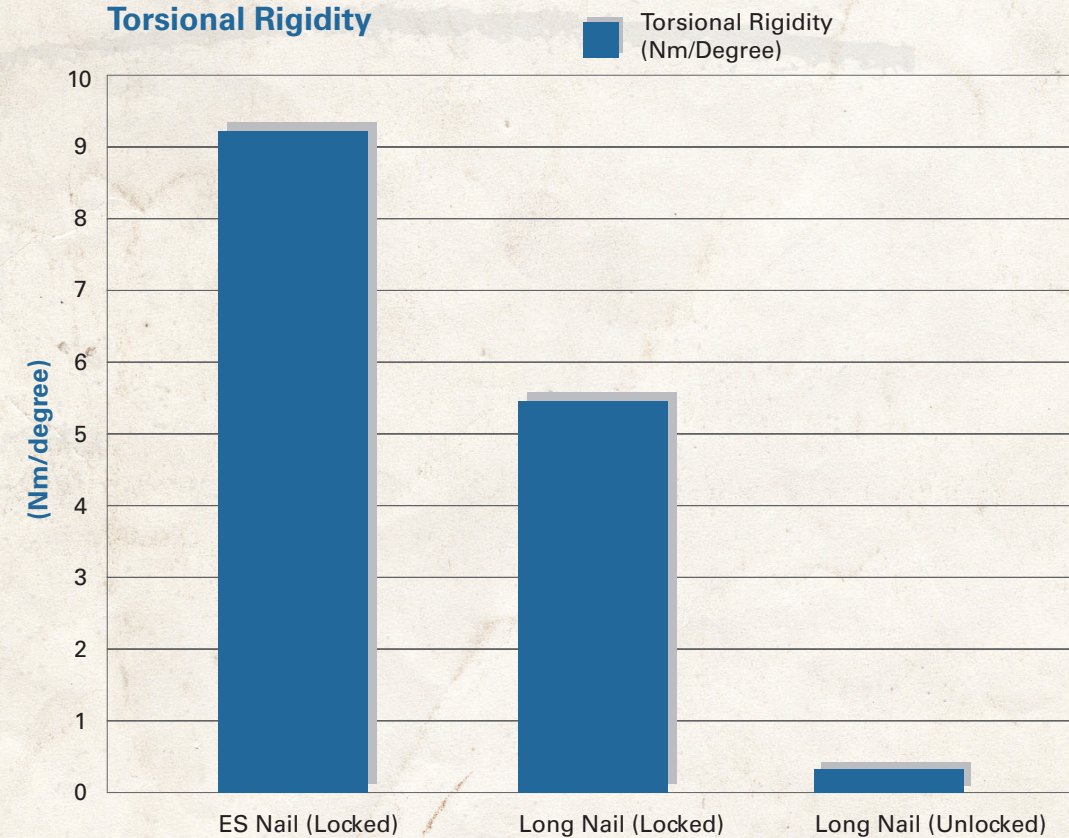

Implant Features

Galileo™ Lag Screw

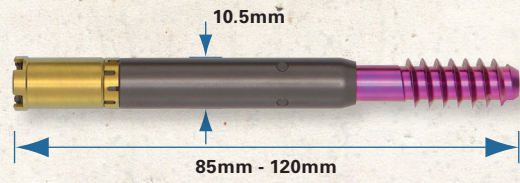

Solid Locking Lag Screw

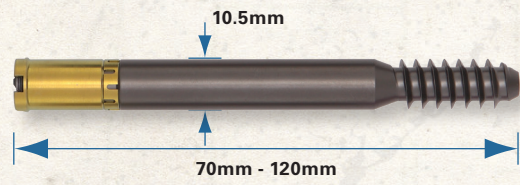

Lag Screw

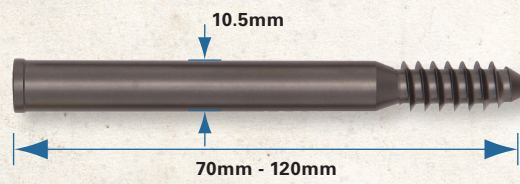

Anti-Rotation Screw

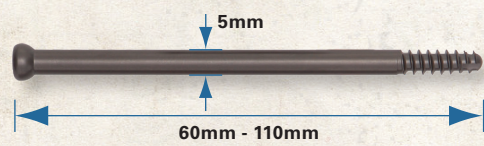

Captured Cortical Screw

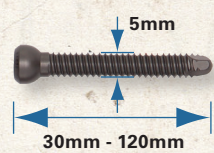

Captured End Caps

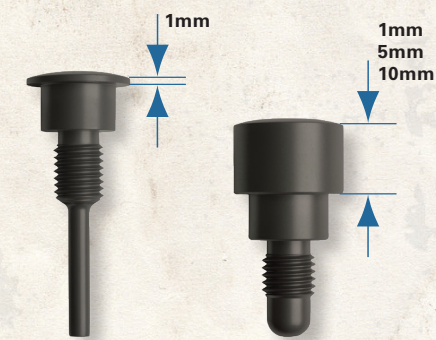

Nail Length (cm)	Radius of Curvature (m)
30	0.9
33	0.9
36	1
39	1.3
42	1.3

Short Nail ES™ Nail Long Nail

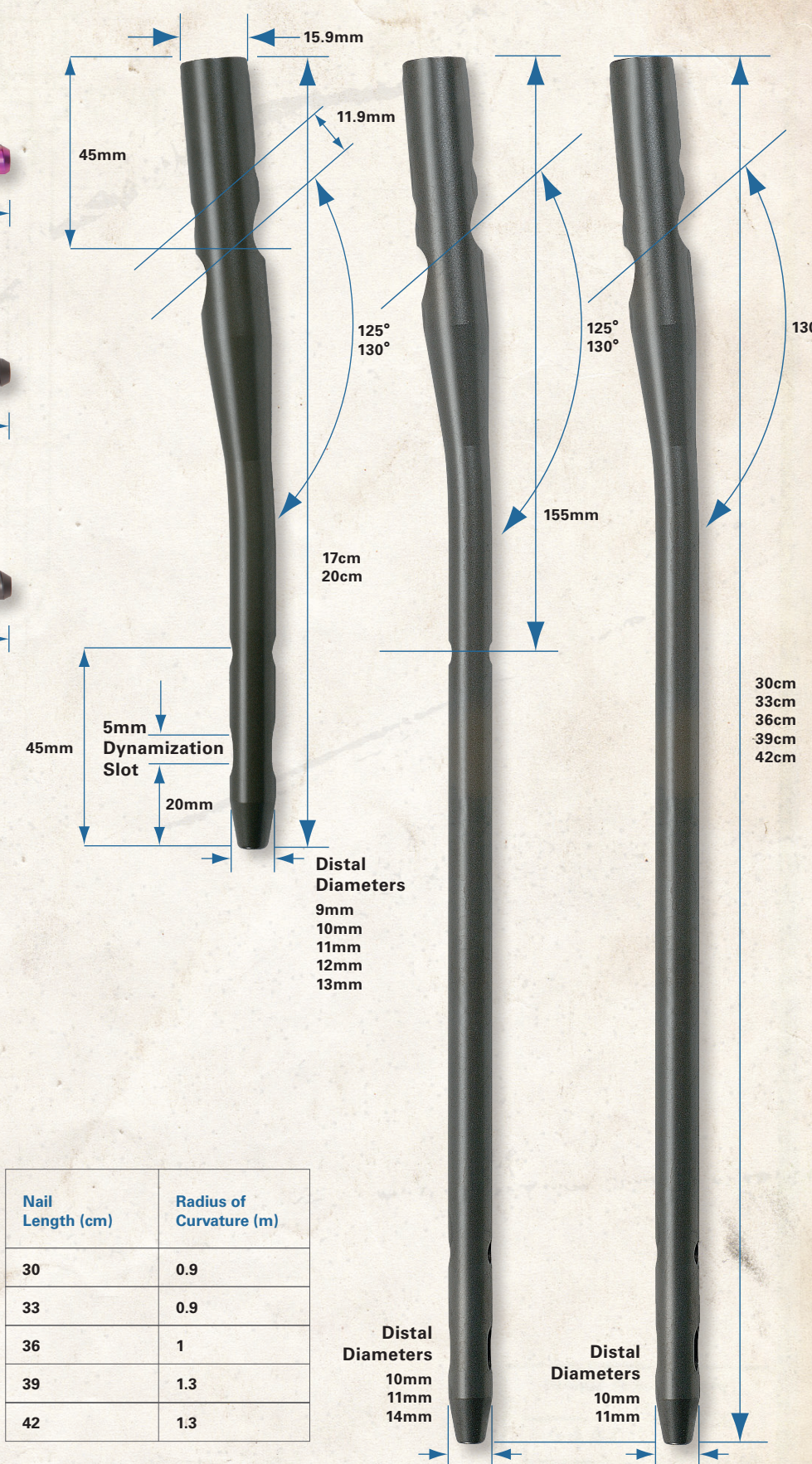

Implant Applications

